

Optical Encoders

Series 61S

High Resolution, 5/8" Package



FEATURES

- Compact, 5/8" Package
- .125" or .250" Shaft Diameter
- 10 Million Rotational Cycles
- Compatible with CMOS, TTL and HCMOS Logic
- Available in 50, 64, 75, 100 and 128 Quadrature Cycles per Revolution
- Choices of Cable Length and Terminations
- Drop-In Industry Replacement

APPLICATIONS

- Audio Mixing Consoles
- Medical Equipment
- Test and Measurement Equipment

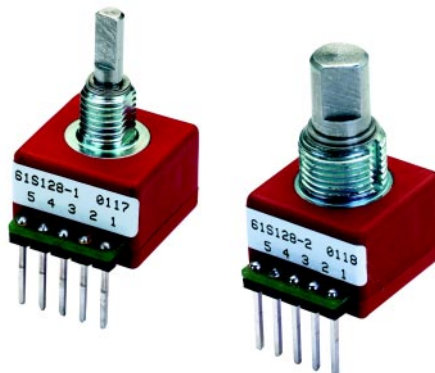

DIMENSIONS In inches (and millimeters)

Pin Version: .125" Shaft

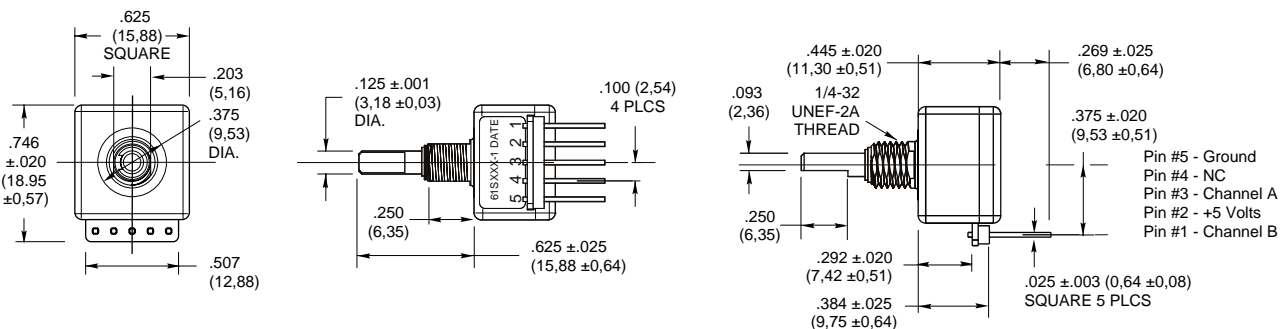

Cable Version: .125" Shaft

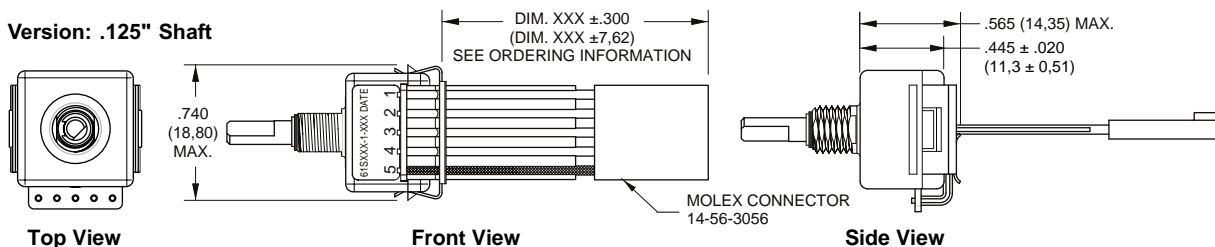

Pin Version: .250" Shaft

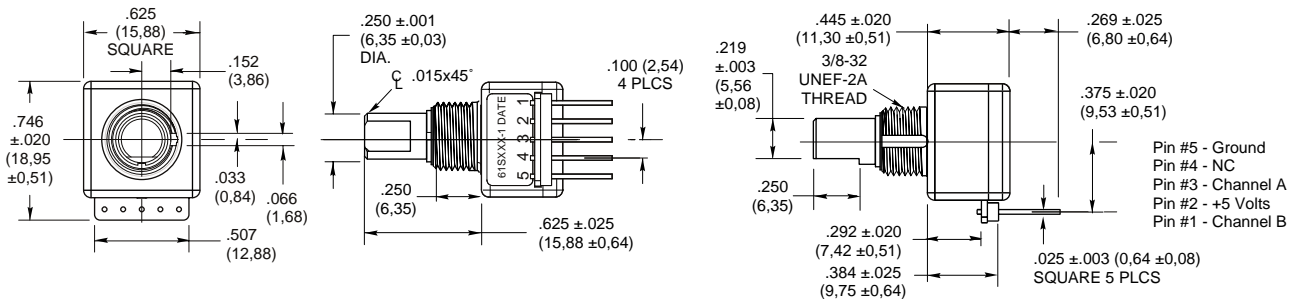

Cable Version: .250" Shaft

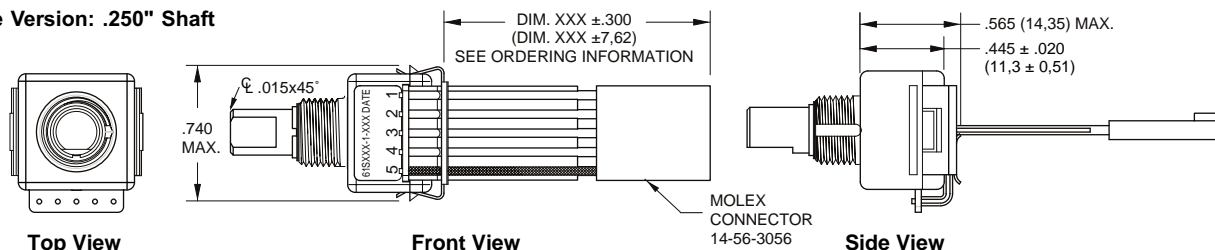

CIRCUITRY AND WAVEFORM Standard Quadrature 2-Bit Code

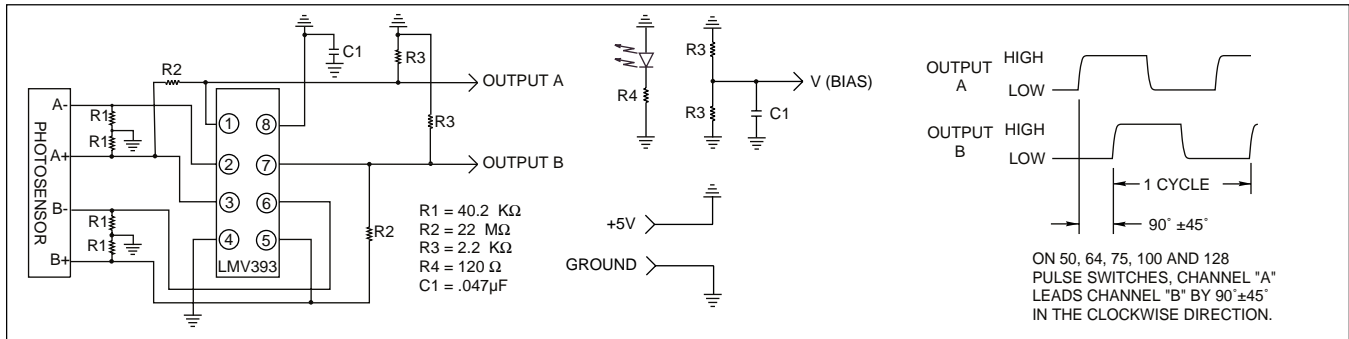

SPECIFICATIONS

Electrical Ratings

Operating Voltage: 5.0 ± .25 Vdc

Supply Current: 50 mA maximum at 5 Vdc

Logic Output Characteristics:

Output Type: 2-bit gray code with channel A leading channel B by 90° ± 45° when the shaft is turned clockwise

Power Consumption: 250 mW maximum

Rise/Fall Times: (25" standard cable ASM/13.3 PF measurement probe)

Rise Time: 1.0 microseconds typical

Fall Time: .440 microseconds typical

Mechanical Ratings

Mechanical Life: 10 million revolutions

Mounting Torque: 20 in-lbs maximum

Operating Torque: 1.5 in-oz maximum

Shaft Push Out Force: 50 lbs minimum

Terminal Strength: 5 lbs terminal pull-out force minimum (pinned version)

Environmental Ratings

Operating Temperature Range: -40°C to 85°C

Storage Temperature Range: -55°C to 100°C

Relative Humidity: 90-95% at 40°C for 96 hours

Vibration Resistance: Harmonic motion with amplitude of 15g, within a varied 10 to 2000 Hz frequency for 12 hours per MIL-STD-202, Method 204

Mechanical Shock: Test 1: 100g for 6 mS, half-sine wave with velocity change of 12.3 ft/s. Test 2: 100g for 6 mS, sawtooth wave with velocity change of 9.7 ft/s.

Materials and Finishes

Bushing: Zinc plated brass

Housing: Nylon (Hiloy 610B)

Shaft: Stainless steel

Code Rotor: Chemically etched stainless steel/ electroformed nickel

Printed Circuit Board: NEMA Grade FR-4.

Five microinches minimum gold over 100 microinches minimum nickel over copper

Backplate: Nylon (Hiloy 610B)

Header: Phosphor bronze, 200 microinches tin over 50 microinches nickel (pinned version)

Retaining Ring and Thrust Washers:

Stainless steel

Photo Sensor: Planar silicon

Infrared Emitter: Gallium aluminum arsenide

Cable: 26 AWG, stranded/tinned wire, PVC coated on .100 (2,54) centers (cabled version)

Connector:

Housing: glass-filled polyester 94V-0, black

Terminals: 15 microinches gold in select area over 50 microinches minimum

ORDERING INFORMATION

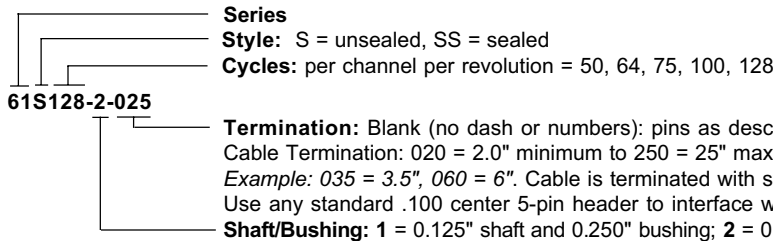

Available from your local Grayhill Component Distributor. For prices and discounts, contact a local Sales Office, an authorized local Distributor.

ACCESSORIES

Non-turn Washers

The Series 61S bushing has a non-turn keyway to prevent rotation of the switch body when the panel is cut to fit. Another way to keep the switch from turning is to use a nonturn washer.

Part Number 50J1066: 302-2B stainless steel

Part number 12C1087-1: cadmium-plated

Part Number SHH694-11: 302-2B

stainless steel, no plating

Shaft and Panel Seal

For shaft and panel seal version, the shaft is sealed by an o-ring inside the bushing. The panel is sealed by a flat gasket .045" thick at the base of the bushing. The panel seals will increase the behind panel dimension by .020"

to .040", when the switch is mounted. The panel seal is silicon rubber. The shaft seal is an o-ring per MIL-P-5516B.

OPTIONS

Contact Grayhill for custom terminations, shaft and bushing configurations, and resolutions. Control knobs are also available.

DIMENSIONS In inches (and millimeters)

