

## SERIES 34A Miniature Toggle Switches

### FEATURES

- Save Space and Weight
- SPDT, DPDT, 3PDT, and 4DPT Circuitry
- Choice of Actuators, Bushings and Terminations
- UL Recognized

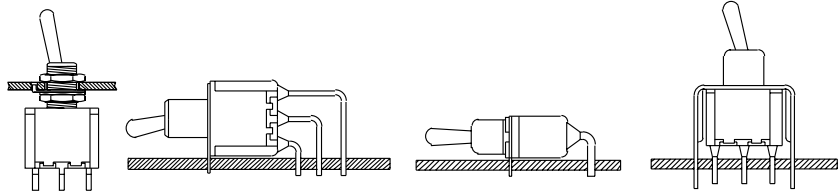

### MODELS In inches (and millimeters)

#### SPDT



Model No.	Switching Position		
SP1	ON	NONE	ON
SP2	ON	NONE	(ON)
SP3	ON	OFF	ON
SP4	(ON)	OFF	(ON)
SP5	ON	OFF	(ON)
Term. Comm.	2-3	OPEN	2-1

Schematic

( ) = Momentary  
 02Comm.

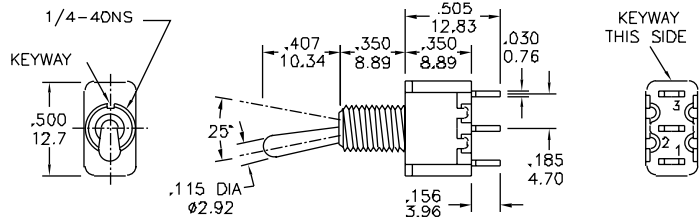

#### DPDT



Model No.	Switching Position		
DP1	ON	NONE	ON
DP2	ON	NONE	(ON)
DP3	ON	OFF	ON
DP4	(ON)	OFF	(ON)
DP5	ON	OFF	(ON)
Term. Comm.	2-3, 5-6	OPEN	2-1, 5-4

Schematic

( ) = Momentary  
 02Comm. 05Comm.

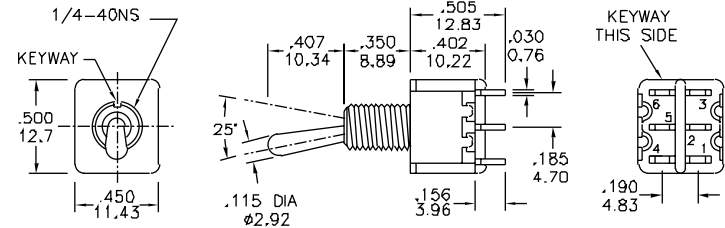

#### 3PDT



Model No.	Switching Position		
3P1	ON	NONE	ON
3P2	ON	NONE	(ON)
3P3	ON	OFF	ON
3P4	(ON)	OFF	(ON)
3P5	ON	OFF	(ON)
Term. Comm.	2-3, 5-6 8-9	OPEN	2-1, 5-4 8-7

Schematic

( ) = Momentary  
 02Comm. 05Comm. 08Comm.

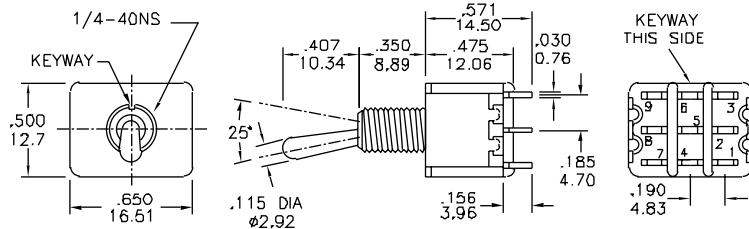

**MODELS** In inches (and millimeters)



Model No.	Switching Position		
4P1	ON	NONE	ON
4P2	ON	NONE	(ON)
4P3	ON	OFF	ON
4P4	(ON)	OFF	(ON)
4P5	ON	OFF	(ON)
Term. Comm.	2-3, 5-6	OPEN	2-1, 5-4
	8-9, 11-12		8-7, 11-10

( ) = Momentary

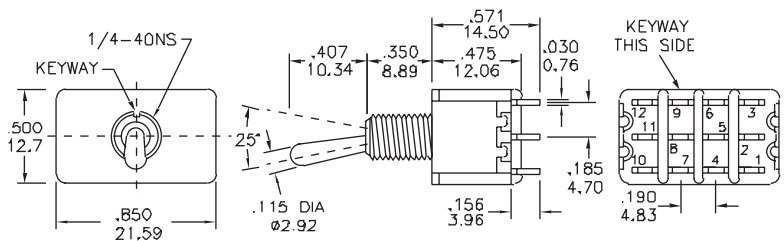

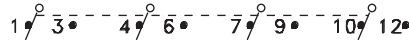
Schematic  
 02Comm, 05Comm, 08Comm, 11Comm.  

Toggle Switches

**ACTUATOR OPTIONS** In inches (and millimeters)

<b>1</b> Std	<b>2</b>	<b>3</b>	<b>4</b>	<b>5</b>
<b>6</b>	<b>7</b>	<b>8</b>	<b>9</b> Nylon, black	<b>0</b>
With Bushing Options B1, B2, B5 only.	For 7, 8 Bushing Option code not required. All other actuator lengths shown with Bushing Option B1.			

**ACTUATOR OPTIONS: For P.C. Mount Terminal Options M6 and M7** In inches (and millimeters)

<b>2</b> Std	<b>1</b>	<b>3</b>	<b>4</b>
Actuator lengths shown with Bushing Option B4			

**BUSHING OPTIONS** In inches (and millimeters)

<p><b>B1</b> Thd (Std) <b>B2</b> Non-Thd</p>	<p><b>B3</b> Thd <b>B4</b> Non-Thd</p>	<p><b>B5</b> High Torque</p>	<p><b>B6</b> High Torque</p>
<p><b>B7</b> Long</p>		<p><b>B8</b> Metric</p>	<p><b>B9</b> Splash-Proof</p>

Toggle Switches

**BUSHING OPTIONS: For P.C. Mount Terminal Options M6 and M7** In inches (and millimeters)

<p><b>B4</b> Non-Thd (Std)</p>
--------------------------------

**PANEL MOUNTING** In inches (and millimeters)

<p><b>1/4" Bushing</b></p>	<p><b>15/32" Bushing</b></p>
----------------------------	------------------------------

**TERMINATION OPTIONS** In inches (and millimeters)

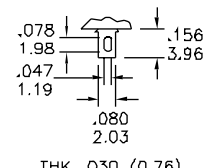
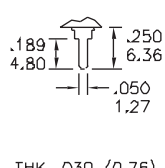
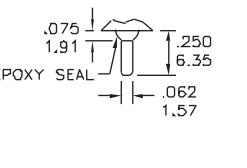
<p><b>M1 Solder Lug (Std)</b></p>  <p>THK .030 (0.76)</p>	<p><b>M2 P.C. Mount</b></p>  <p>THK .030 (0.76)</p>	<p><b>M3 P.C. Mount, Quick Connect</b></p>  <p>EPOXY SEAL</p>
--	--	--

**M6 Right Angle P.C. Mount, Horizontal Actuation**



**SPDT**

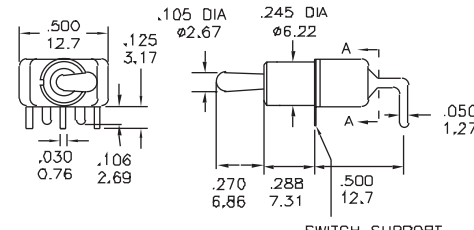

SWITCH SUPPORT

P.C. MOUNTING

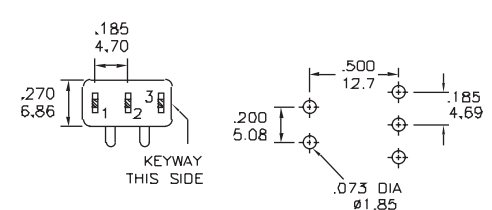

KEYWAY THIS SIDE



**DPDT**

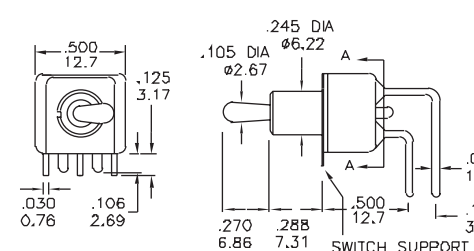

SWITCH SUPPORT

P.C. MOUNTING

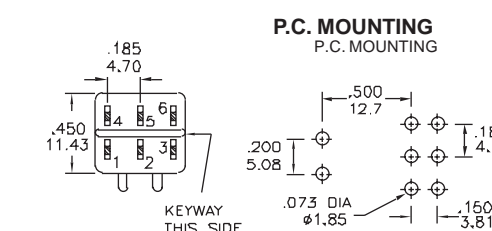

KEYWAY THIS SIDE

**M7 Right Angle P.C. Mount, Vertical Actuation**



**SPDT**

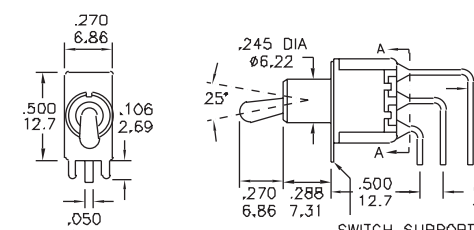

SWITCH SUPPORT

P.C. MOUNTING

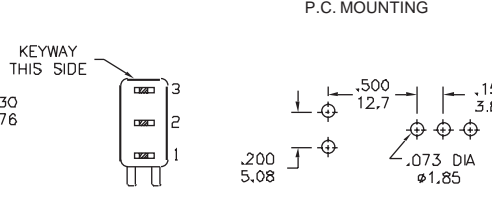

KEYWAY THIS SIDE

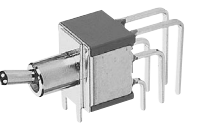

**DPDT**

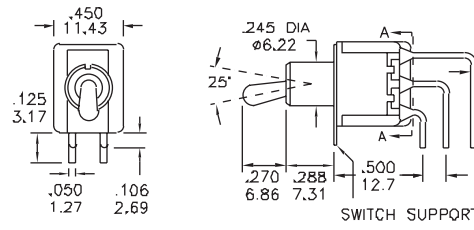

SWITCH SUPPORT

P.C. MOUNTING

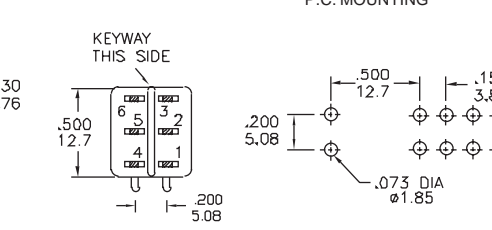

KEYWAY THIS SIDE

SECTION A-A

**TERMINATION OPTIONS** In inches (and millimeters)

**3PDT**

TERM. NOS. FOR REFERENCE ONLY

SWITCH SUPPORT

KEYWAY THIS SIDE

SECTION A-A

P.C. MOUNTING

**4PDT**

TERM. NOS. FOR REFERENCE ONLY

SWITCH SUPPORT

KEYWAY THIS SIDE

SECTION A-A

P.C. MOUNTING

Toggle Switches

**V2-V3 Vertical Bracket P.C. Mount**

**SPDT**

EPOXY SEAL

OPTION CODE	DIM. 'A'
V2	.460 (11,68)
V3	.630 (16,00)

P.C. MOUNTING

**DPDT**

EPOXY SEAL

OPTION CODE	DIM. 'A'
V2	.460 (11,68)
V3	.630 (16,00)

P.C. MOUNTING

**SPECIFICATIONS**

**RATINGS**

Contact Rating: Q option- 5A with resistive load @125 VAC or 28 VDC; 2A with resistive load @ 250 VAC. R option- 0.4VA max @ 20 Vmax (AC or DC)

**Electrical Life:** 50,000 make-and-break cycles at full load

**Contact Resistance:** 10 milliohms max. initial @ 2-4 VDC, 100 mA

**Insulation Resistance:** 1,000 megaohms minimum

**Dielectric Strength:** 1,000 V RMS @ sea level

**Operating Temperature:** -30°C to 85°C

**MATERIALS**

**Case:** Diallyl phthalate (DAP) (UL94V-0)

**Toggle Handle:** Brass, chrome-plated

**Bushing:** Brass, nickle-plated

**Housing:** Stainless steel

**ORDERING INFORMATION**

SERIES	MODEL NO.	ACTUATOR	BUSHING	TERMINATION	CONTACT	SEAL
34A	SP1	2	B4	M2	R	E
34A = Miniature Toggle Switches	Options: SP1, SP2, SP3, SP4, SP5, DP1, DP2, DP3, DP4, DP5, 3P1, 3P2, 3P3, 3P4, 3P5, 4P1, 4P2, 4P3, 4P4, 4P5 (see models for switching positions)	Options: 1, 2, 3, 4, 5, 6, 7, 8, 9, 0 (see actuator options)	Options: B1, B2, B3, B4, B5, B6, B7, B8, B9 (see bushing options)	Options: M1, M2, M3, M6, M7, V2, V3 (see termination options)	R = Copper alloy, gold plate over nickel plate.  Q = End terminal contact surface: coin silver Center terminal contact surface: copper alloy, silver plated	E = Epoxy seal
<b>Example Part Number:</b> 34ASP12B4M2RE						

Available from your local Grayhill Component Distributor. For prices and discounts, contact a local Sales Office, an authorized local Distributor In Beijing, CHINA, Phone: (010)6858-5001, Fax: (010)6851-9889

**HARDWARE** In inches (and millimeters)

**NUTS**

Series 100 (Std)

HDW2

Dress Nut

HDW3

For Actuator Options 7, 8 (Std)

HDW4

Knurled Nut (Sealed)

HDW5

**LOCKING RINGS**

Series 100 (Std)

HDW15

For Actuator Options 7, 8

HDW16

HDW17

**LOCK WASHERS**

Series 100 (Std)

HDW11

For Actuator Options 7, 8

HDW12